

wiring diagram DEUTZ TEM-Evo

Contents

| | |
|-----|---|
| 000 | Contents |
| 001 | remarks |
| 002 | reserved |
| 003 | security chain external |
| 004 | enable power switch |
| 005 | interface to gas control system |
| 006 | reserved |
| 007 | Low water protection |
| 008 | reserved (8-9) |
| 010 | supply TEM cabinet (+AlT1) |
| 011 | gas valves, starter, ignition |
| 012 | circuit breakers |
| 013 | secu.chain,quick stop, reset,emerg. switch |
| 014 | data lines CPU, CAN-BUS and ignition |
| 015 | Turning device, preheating genset |
| 016 | combustion chamber temp., bank A, receiver |
| 017 | combustion chamber temp., bank B, receiver |
| 018 | voltage supply +/- 15 V analog inputs |
| 019 | temperature, pressure + oil level measure. genset |
| 020 | temperature and pressure measurement:genset |
| 021 | temperature measurement: generator windings |
| 022 | temperature measurement: generator bearings |
| 023 | ATL speed |
| 024 | reserved |
| 025 | reserve terminals |
| 026 | reserve terminals |
| 027 | reserved |
| 028 | transmitter exhaust back pressure |
| 029 | interface anti-knock governor |
| 030 | interface speed governor |
| 031 | reserved |
| 032 | stepper motor card, mixer, bank A |
| 033 | stepper motor card, mixer, bank B |
| 034 | triggering aux. relay, speed governor, starter |
| 035 | serial interface for site control syst. |
| 036 | interface to operating terminal and IAE |
| 037 | reserved |
| 038 | slot overview TEM terminal |
| 039 | cable inlets base plate |
| 040 | material list |

| | | | |
|--------------|----------|---------------|------------------|
| Date | 25.01.07 | Plant | Bogra Bangladesh |
| Resp. | Schild | Plant section | |
| Chkd. | Bardel | Engine | |
| State/modif. | Date | name | Norm |
| | 07.09.07 | | 01.10.03 |
| | 05.02.07 | | |
| | | Source | replacem. f. |



Designation
wir.diagram
TEM-Evo-AGS

Order no.
646324/646325/646326/
646328/646329/646331

Type
TCG 2032 V16

=A1
+T1

part number
1247 4827 UE

Identure no.
0479-91

page 0
from 40

reserved

| | | | | | | | | | | | |
|-------|--------|------|-------|----------|---------------|------------------|---|--------------|---|--------------|---------|
| | | | Date | 25.01.07 | Plant | Bogra Bangladesh |  © 2006 | Designation | Order no. | Type | =A1 |
| | | | Resp. | Schild | Plant section | | | wir.diagram | 646324/646325/646326/ 646328/646329/646331 | TCG 2032 V16 | +T1 |
| | | | Chkd. | Bardel | Engine | | | TEM-Evo-AGS | part number | Identure no. | page |
| State | modif. | Date | name | Norm | 25.01.06 | Source | replacem. f. | 1247 4827 UE | 0479-91 | from | 2 40 |

-D133
13.2

I/QX...1.02

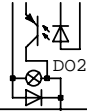

-J133 14

WH/GN

3.5 W133 - 13.2
-W133

-K110 11.1
6

3.9 L- 10.2

-X44 1 2

TEM
external

+ -
enable (demand)
power switch
+24V at enable
(demand)

enable power switch

| | | | | | | | | | | | | |
|-------|--------|------|-------|----------|---------------|------------------|--------------|---|---|--------------|--------------|---------|
| | | | Date | 25.01.07 | Plant | Bogra Bangladesh | |  © 2006 | Designation | Order no | Type | =A1 |
| | | | Resp. | Schild | Plant section | | wir.diagram | | 646324/646325/646326/ 646328/646329/646331 | TCG 2032 V16 | +T1 | |
| | | | Chkd. | Bardel | Engine | | TEM-Evo-AGS | | part number | 1247 4827 UE | Identure no. | 0479-91 |
| State | modif. | Date | name | Norm | 25.01.06 | Source | replacem. f. | | | | | from 40 |

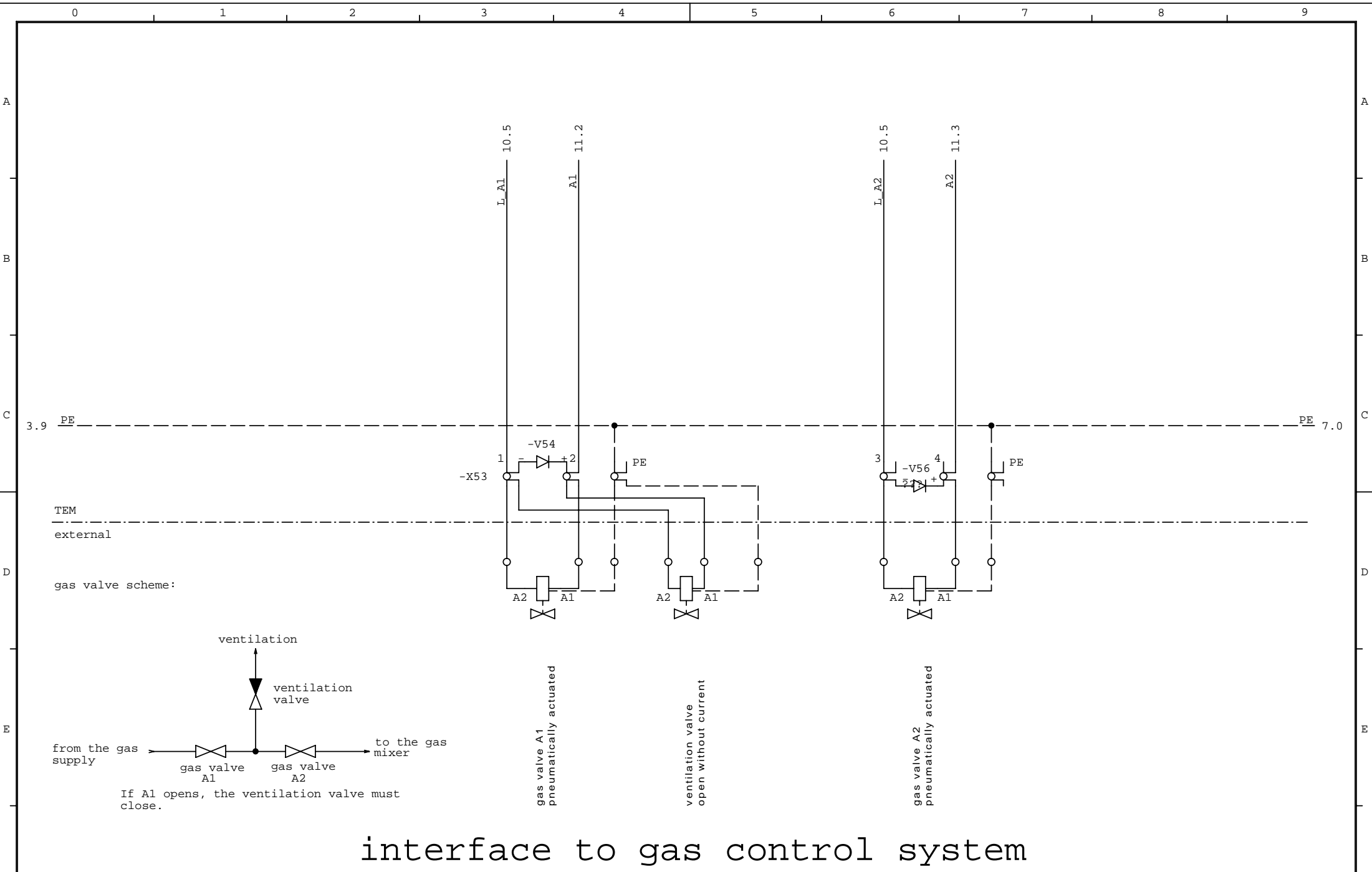

interface to gas control system

| | | | | | | | | | | | | | | | | |
|-------|----------|------|-------|----------|---------------|------------------|--------------|--|--|--|-----------|---|--------------|--------------|---------|---------|
| | | | Date | 25.01.07 | Plant | Bogra Bangladesh | | | | | Order no. | 646324/646325/646326/ 646328/646329/646331 | Type | =A1 | | |
| | | | Resp. | Schild | Plant section | | | | | | | | TCG 2032 V16 | +T1 | | |
| | 07.09.07 | | Chkd. | Bardel | Engine | | | | | | | | | page 5 | | |
| State | modif. | Date | name | Norm | 25.01.06 | Source | replacem. f. | | | | | part number | 1247 4827 UE | Identure no. | 0479-91 | from 40 |



© 2006

Designation
wir.diagram
TEM-Evo-AGS

Order no.
646324/646325/646326/
646328/646329/646331
part number
1247 4827 UE
Identure no.
0479-91

0 1 2 3 4 5 6 7 8 9

A

A

B

B

C

C

D

D

E

E

F

F

reserved

| | | | | | | | | | | | |
|-------|----------|------|-------|----------|---------------|------------------|---|--------------|---|--------------|------|
| | | | Date | 25.01.07 | Plant | Bogra Bangladesh |  © 2006 | Designation | Order no. | Type | =A1 |
| | | | Resp. | Schild | Plant section | | | wir.diagram | 646324/646325/646326/ 646328/646329/646331 | TCG 2032 V16 | +T1 |
| | 05.02.07 | | Chkd. | Bardel | Engine | | | TEM-Evo-AGS | part number | Identure no. | page |
| State | modif. | Date | name | Norm | 25.01.06 | Source | replacem. f. | 1247 4827 UE | 0479-91 | from | 40 |

0 1 2 3 4 5 6 7 8 9

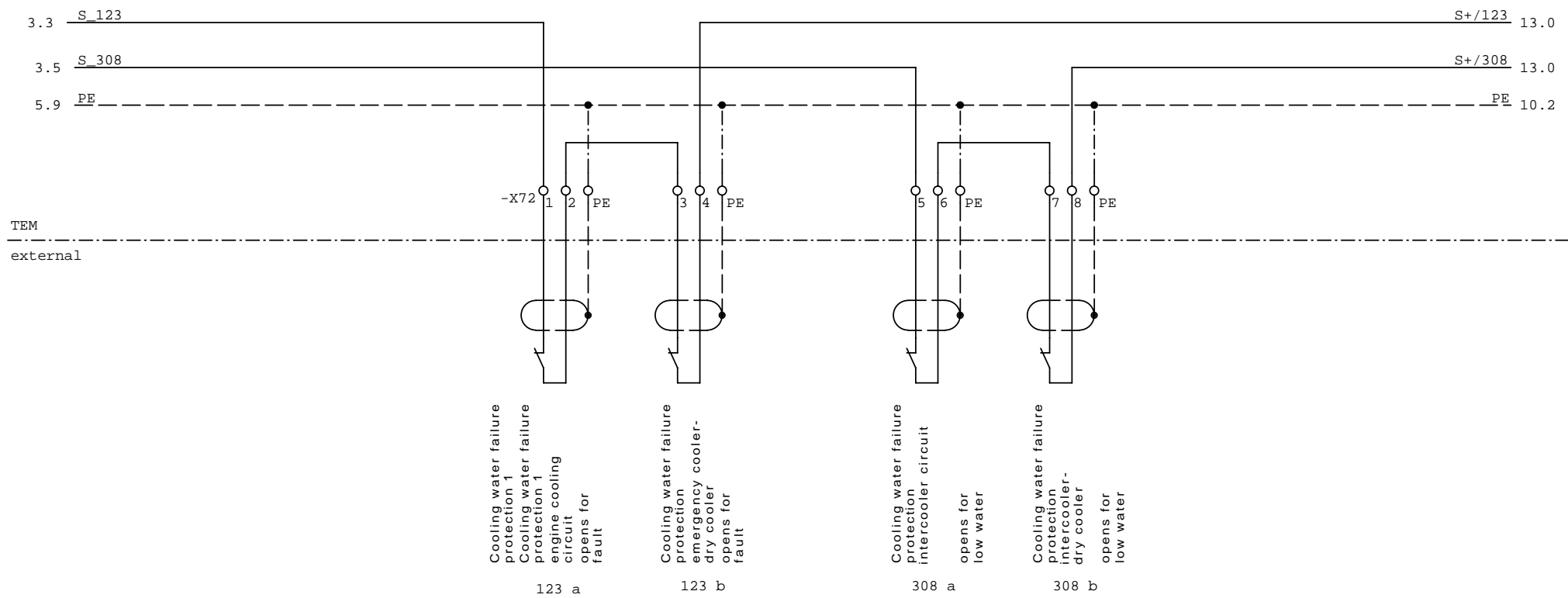

Low water protection

| | | | | | | | | | | | | | | | | | |
|-------|----------|------|------|-------|----------|---------------|------------------|--|---|--------|-----------------------------------|---|--------------|----------------|----------------|------|----|
| | | | | Date | 25.01.07 | Plant | Bogra Bangladesh | | | | Order no. | 646324/646325/646326/ 646328/646329/646331 | | Type | =A1 | | |
| | | | | Resp. | Schild | Plant section | | |  | © 2006 | Designation wir.diagram | | TCG 2032 V16 | +T1 | | | |
| | 05.02.07 | | | Chkd. | Bardel | Engine | | | | | part number | 1247 4827 | UE | Identure no. | 0479-91 | page | 7 |
| State | modif. | Date | name | Norm | 25.01.06 | Source | replacem. f. | | | | 1247 4827 | | UE | 0479-91 | | from | 40 |

reserved (8-9)

| | | | | | | | | | | | |
|-------|----------|------|-------|----------|---------------|------------------|--|--------------|---|--------------|------|
| | | | Date | 25.01.07 | Plant | Bogra Bangladesh |  © 2006 | Designation | Order no. | Type | =A1 |
| | | | Resp. | Schild | Plant section | | | wir.diagram | 646324/646325/646326/ 646328/646329/646331 | TCG 2032 V16 | +T1 |
| | 05.02.07 | | Chkd. | Bardel | Engine | | | TEM-Evo-AGS | part number | Identure no. | page |
| State | modif. | Date | name | Norm | 25.01.06 | Source | replacem. f. | 1247 4827 UE | 0479-91 | from | 40 |

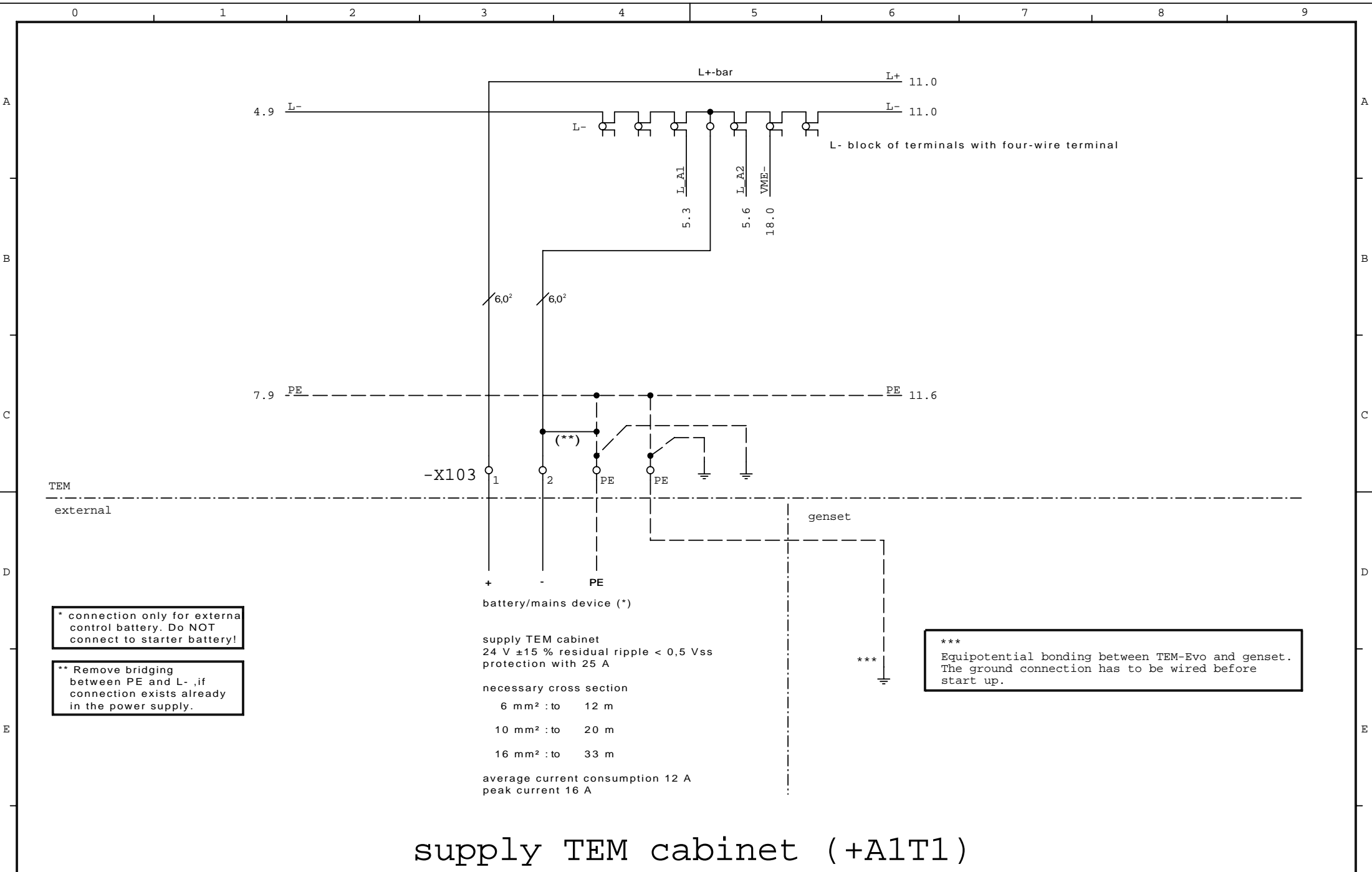

* connection only for external control battery. Do NOT connect to starter battery!

** Remove bridging between PE and L- ,if connection exists already in the power supply.

supply TEM cabinet
24 V ±15 % residual ripple < 0,5 V_{ss}
protection with 25 A

necessary cross section
6 mm² : to 12 m
10 mm² : to 20 m
16 mm² : to 33 m

average current consumption 12 A
peak current 16 A

Equipotential bonding between TEM-Evo and genset. The ground connection has to be wired before start up.

| | | | | | | | | | | | | | |
|-------|----------|------|-------|----------|---------------|------------------|--------------|---|-------------|---|--------------|------------|----|
| | | | Date | 25.01.07 | Plant | Bogra Bangladesh | |  © 2006 | Designation | Order no. | Type | | |
| | | | Resp. | Schild | Plant section | | | | wir.diagram | 646324/646325/646326/ 646328/646329/646331 | TCG 2032 V16 | =A1 +T1 | |
| | 07.09.07 | | Chkd. | Bardel | Engine | | | | TEM-Evo-AGS | part number | Identure no. | page | 10 |
| State | modif. | Date | name | Norm | 25.01.06 | Source | replacem. f. | | | 1247 4827 UE | 0479-91 | from | 40 |

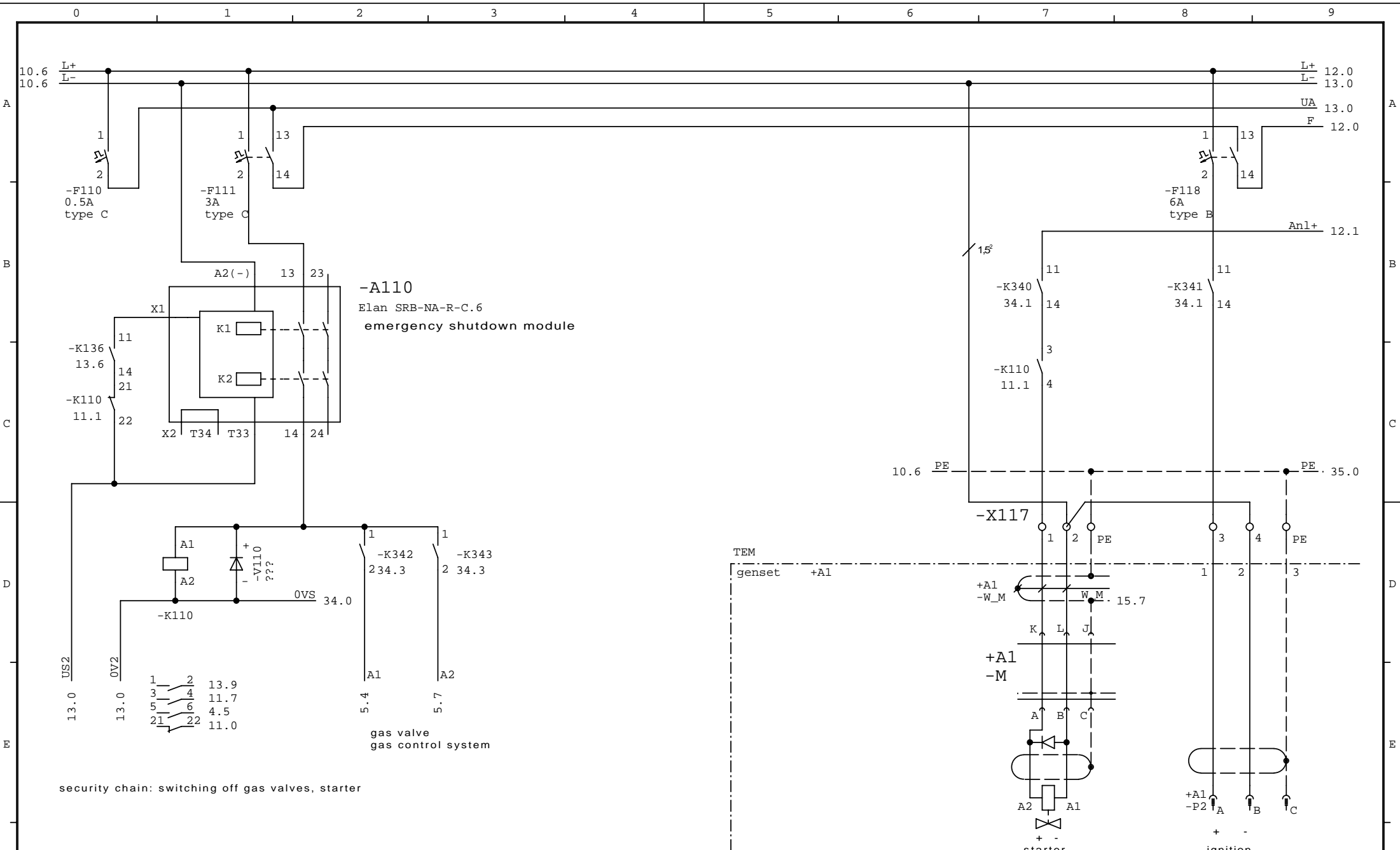

gas valves, starter, ignition

Homologation of all relay under VDE 0435
All contactors under VDE 0660

| | | | | | | | | | | | | |
|-------|--------|----------|---------------|------|------------------|---|--------------|--|---|--|--------------|--------------|
| Date | | 25.01.07 | Plant | | Bogra Bangladesh |  © 2006 | Designation | | Order no. | | Type | =A1 |
| Resp. | | Schild | Plant section | | | | wir.diagram | | 646324/646325/646326/ 646328/646329/646331 | | TCG 2032 V16 | +T1 |
| Chkd. | | Bardel | Engine | | | | TEM-Evo-AGS | | part number | | 1247 4827 UE | Identure no. |
| State | modif. | Date | name | Norm | 25.01.06 | Source | replacem. f. | | | | 0479-91 | from 40 |

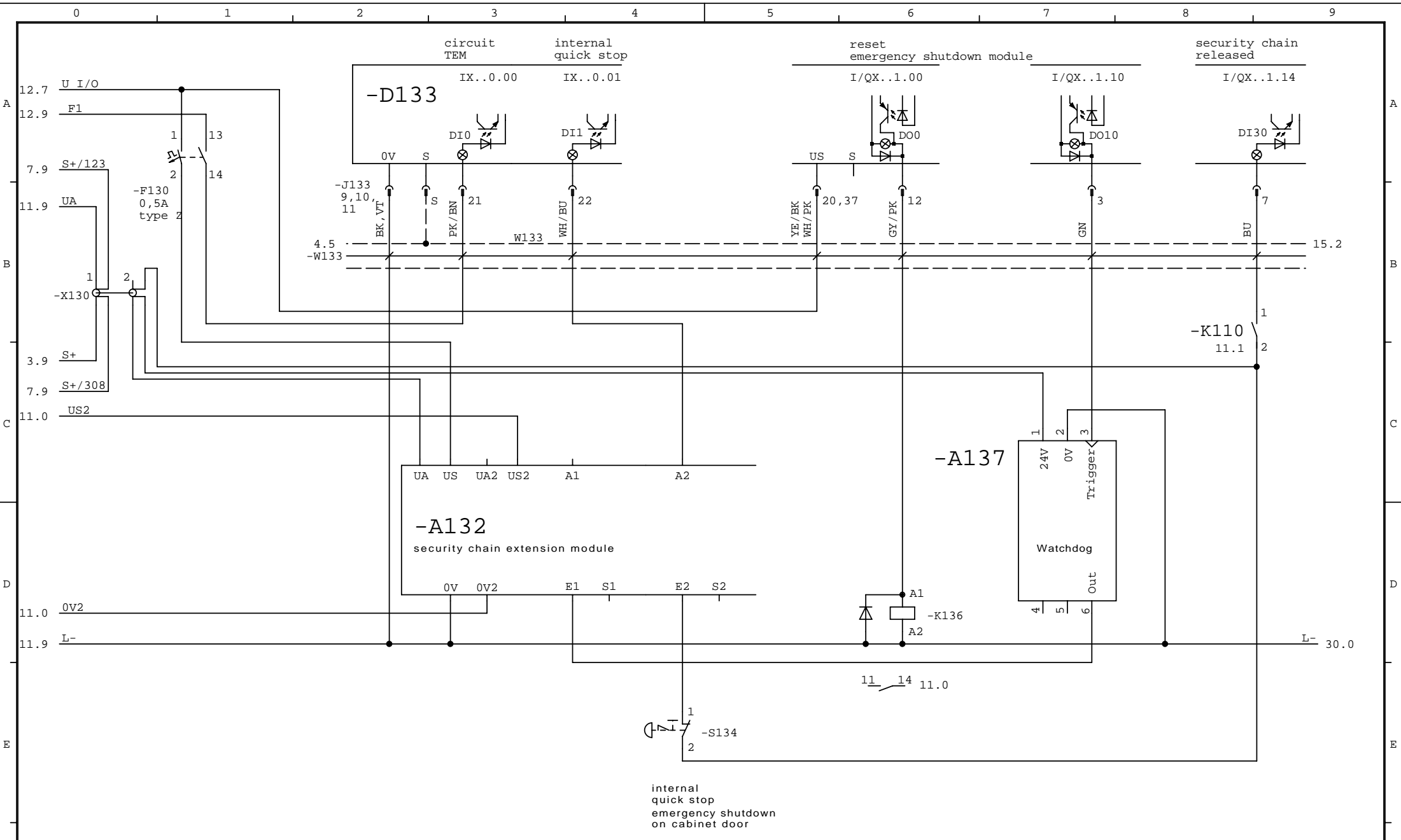

secu.chain, quick stop, reset, emerg. switch

| | | | | | | | | | | | | |
|-------|--------|----------|---------------|------|------------------|---|-------------|---|-------------|--------------|--------------|---------|
| Date | | 25.01.07 | Plant | | Bogra Bangladesh |  © 2006 | Designation | | Order no | Type | =A1 | |
| Resp. | | Schild | Plant section | | Engine | | wir.diagram | 646324/646325/646326/ 646328/646329/646331 | | TCG 2032 V16 | +T1 | |
| State | modif. | Date | name | Norm | 25.01.06 | | Source | replacem. f. | part number | 1247 4827 UE | Identure no. | 0479-91 |
| | | | | | | | | | | | from 40 | |

-D144

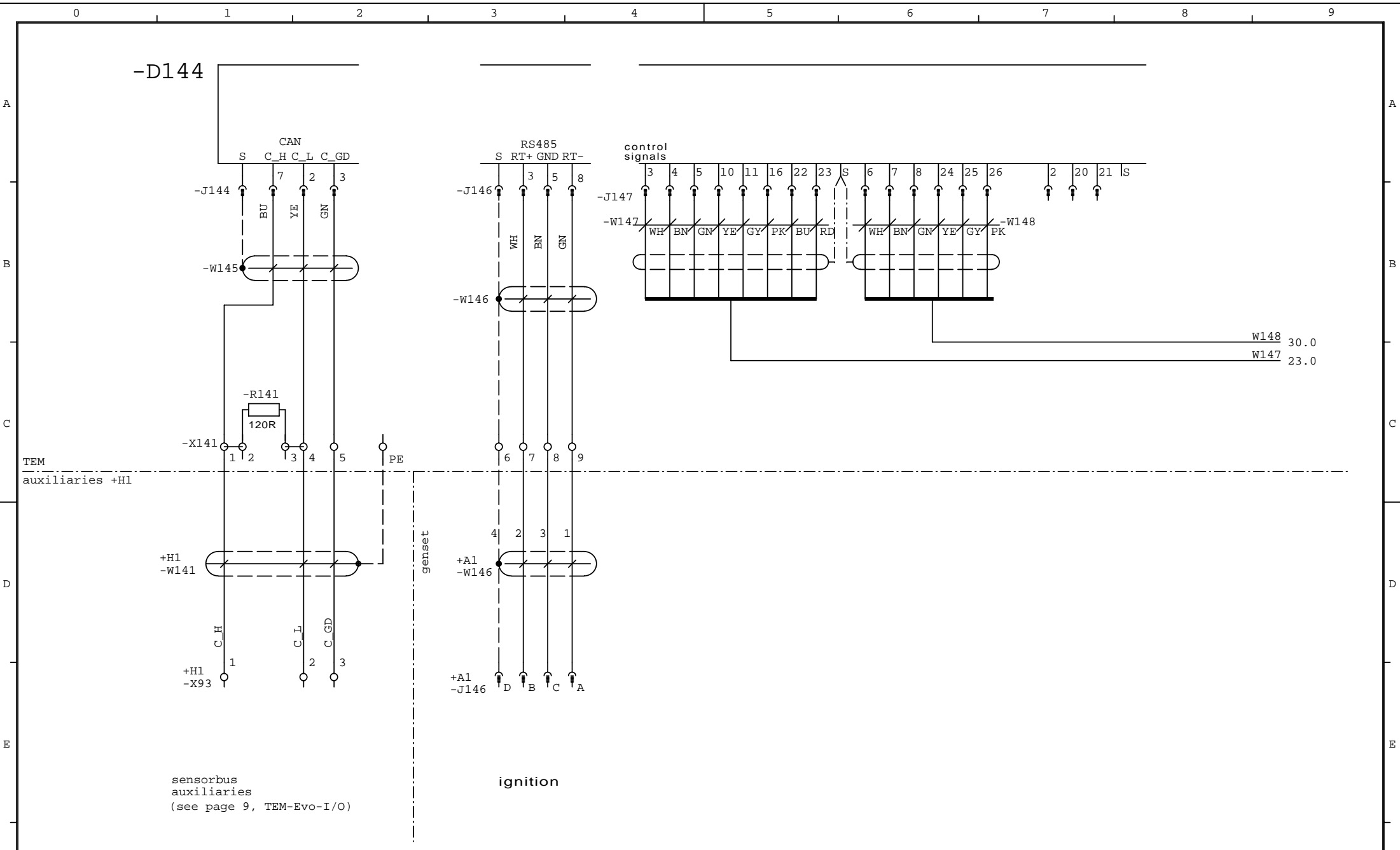

W148 30.0
W147 23.0

data lines CPU, CAN-BUS and ignition

| | | | | | | | | | | |
|-------|--------|-------|----------|---------------|------------------|---|--------------|---|--------------|---------|
| | | Date | 25.01.07 | Plant | Bogra Bangladesh |  © 2006 | Designation | Order no. | Type | =A1 |
| | | Resp. | Schild | Plant section | Engine | | wir.diagram | 646324/646325/646326/ 646328/646329/646331 | TCG 2032 V16 | +T1 |
| | | Chkd. | Bardel | Source | replacem. f. | | TEM-Evo-AGS | part number | Identure no. | page 14 |
| State | modif. | Date | name | Norm | 25.01.06 | | 1247 4827 UE | 0479-91 | from 40 | |

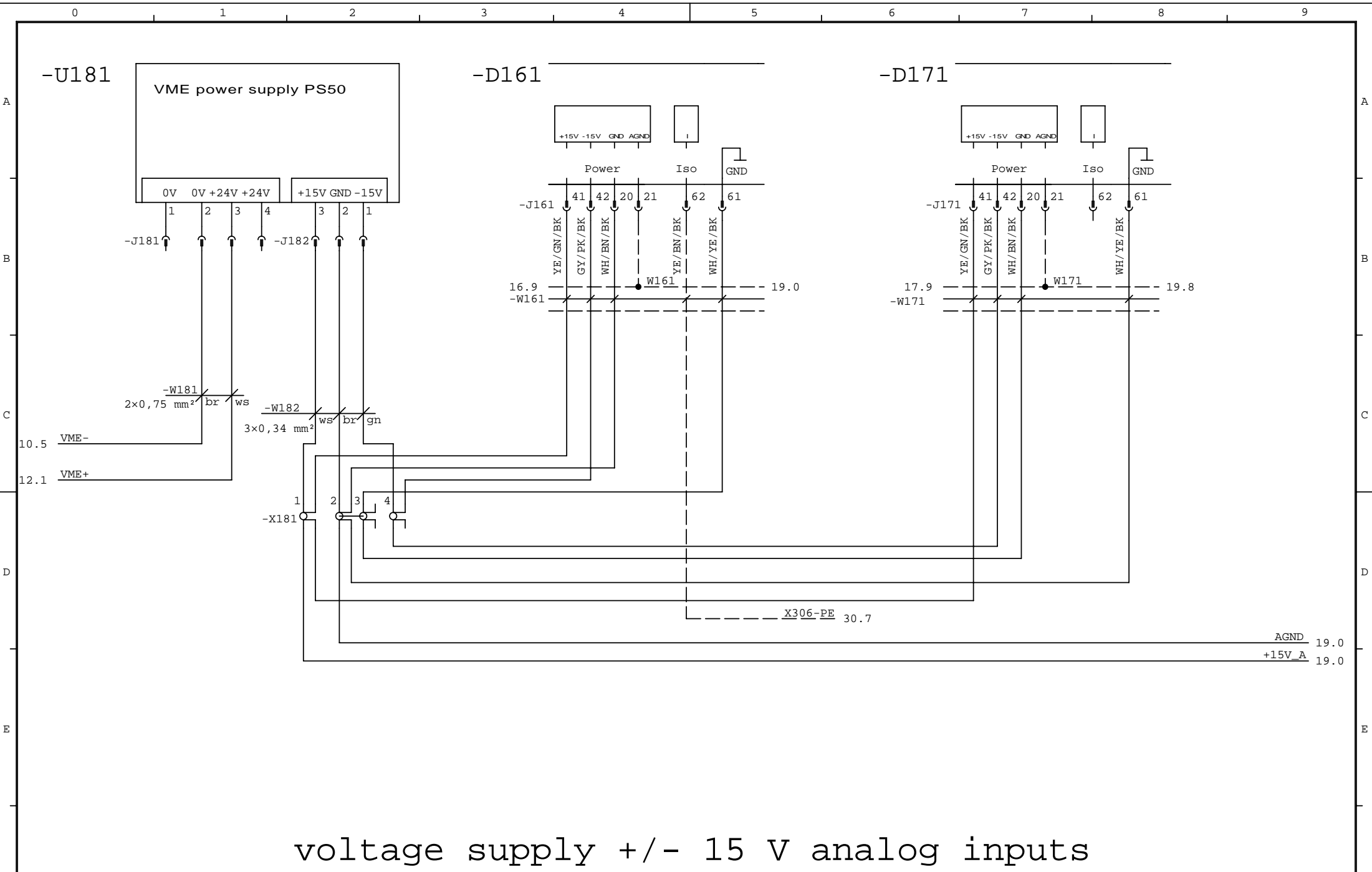

voltage supply +/- 15 V analog inputs

| | | | | | | | | | | | | | | |
|-------|--------|------|-------|----------|---------------|------------------|--------------|---|-------------|---|--------------|---------|------|----|
| | | | Date | 25.01.07 | Plant | Bogra Bangladesh | |  © 2006 | Designation | Order no | Type | =A1 | | |
| | | | Resp. | Schild | Plant section | | | | wir.diagram | 646324/646325/646326/ 646328/646329/646331 | TCG 2032 V16 | +T1 | | |
| | | | Chkd. | Bardel | Engine | | | | TEM-Evo-AGS | part number | Identure no. | page | 18 | |
| State | modif. | Date | name | Norm | 25.01.06 | Source | replacem. f. | | 1247 | 4827 | UE | 0479-91 | from | 40 |

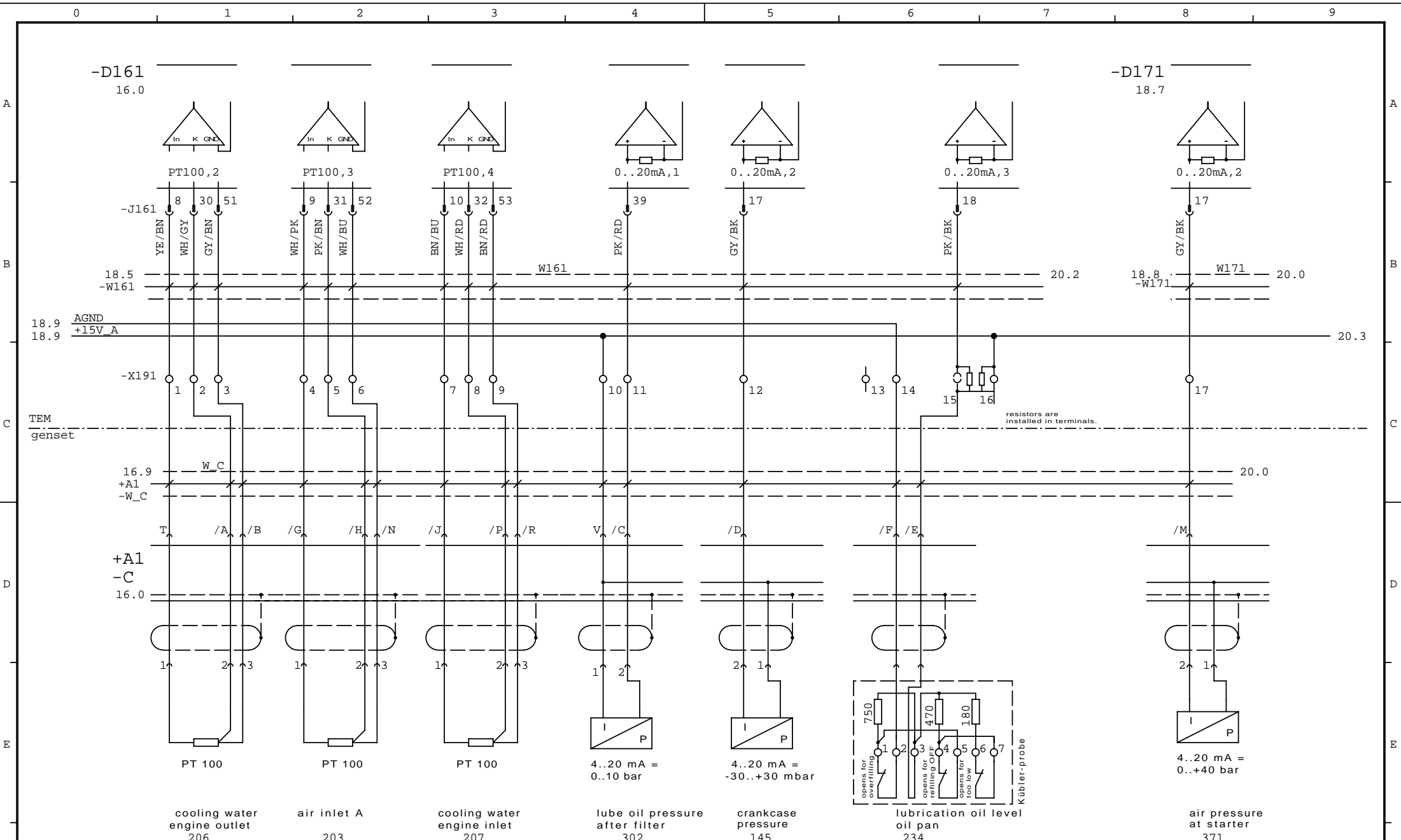

temperature, pressure + oil level measure. genset

| | | | | | | | | | | |
|-------|--------|----------|---------------|------------------|---|-------------|---|--------------|---------|---------|
| | Date | 25.01.07 | Plant | Bogra Bangladesh |  | Designation | Order no | Type | =A1 | |
| | Resp. | Schild | Plant section | | © 2006 | wir.diagram | 646324/646325/646326/ 646328/646329/646331 | TCG 2032 V16 | +T1 | |
| | Chkd. | Bardel | Engine | | | TEM-Evo-AGS | part number | Identure no. | page 19 | |
| State | modif. | Date | name | Norm | 25.01.06 | Source | replacem. f. | 1247 4827 UE | 0479-91 | from 40 |

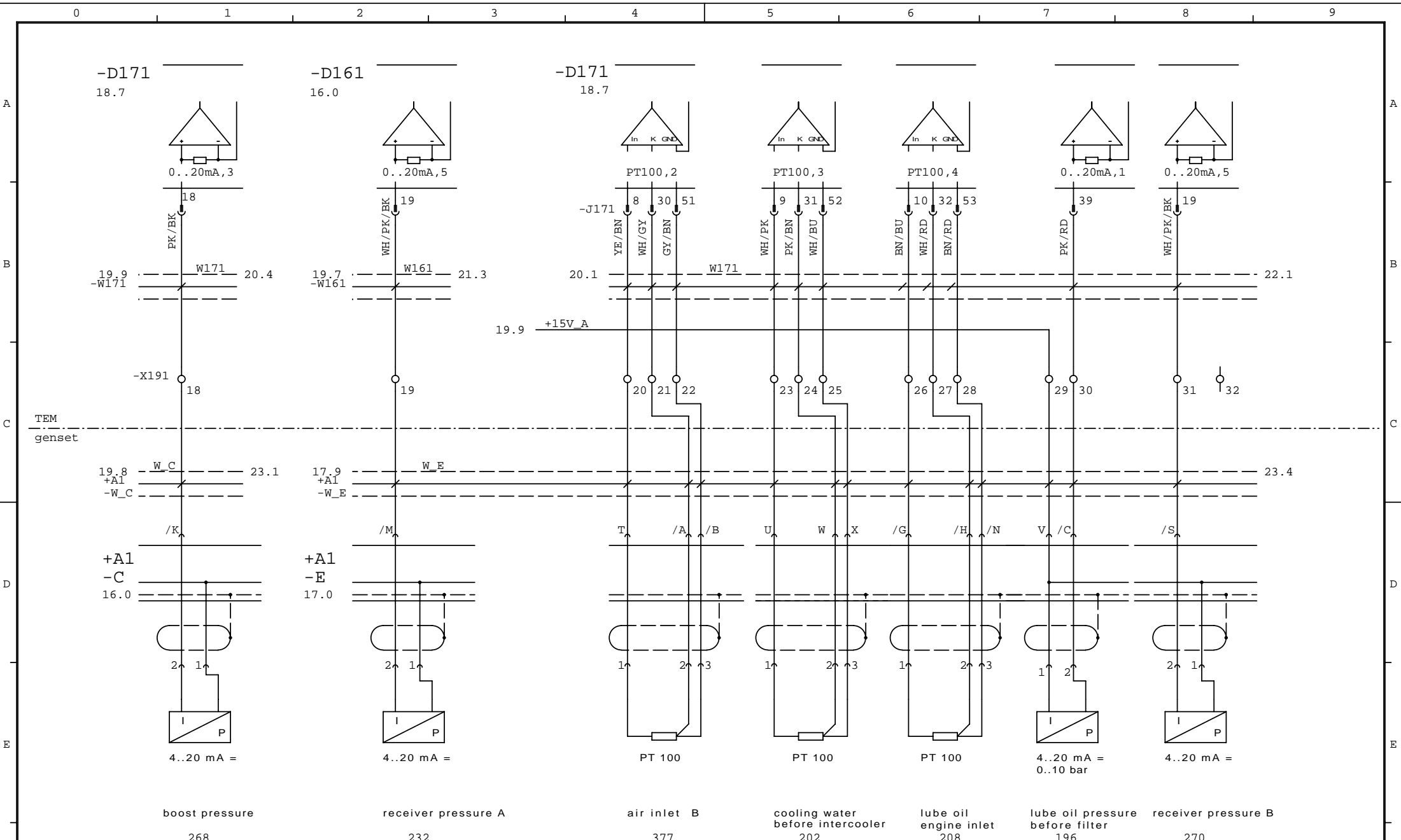

temperature and pressure measurement: genset

| | | | | | | | | | | | | |
|-------|--------|------|-------|----------|---------------|------------------|--------------|------------|--------------|---|--------------|------|
| | | | Date | 25.01.07 | Plant | Bogra Bangladesh | | © 2006 | Designation | Order no | Type | =A1 |
| | | | Resp. | Schild | Plant section | | | | wir.diagram | 646324/646325/646326/ 646328/646329/646331 | TCG 2032 V16 | +T1 |
| | | | Chkd. | Bardel | Engine | | | | TEM-Evo-AGS | part number | Identure no. | page |
| State | modif. | Date | name | Norm | 25.01.06 | Source | replacem. f. | | 1247 4827 UE | 0479-91 | from | 40 |

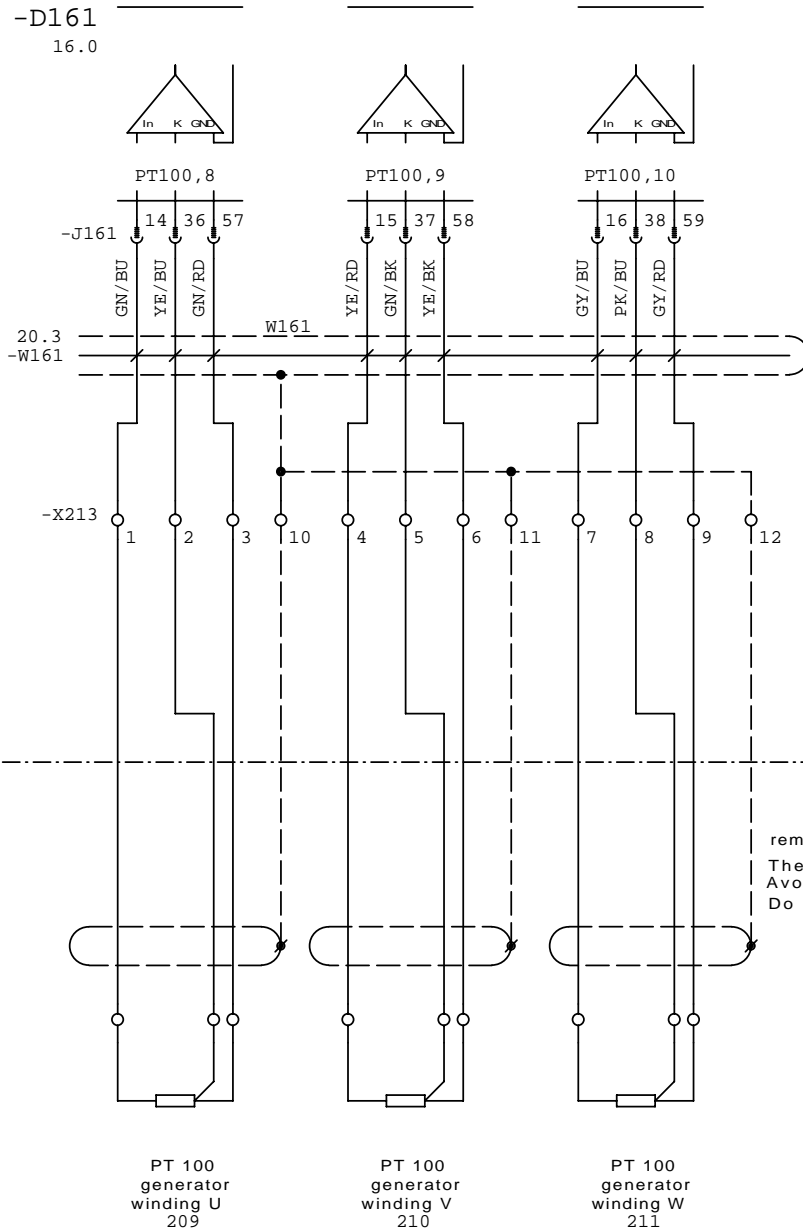

temperature measurement: generator windings

| | | | | | | | | | | | | | | |
|-------|--------|------|-------|----------|---------------|------------------|--------------|------------|-------------|---|--------------|---------|------|----|
| | | | Date | 25.01.07 | Plant | Bogra Bangladesh | | © 2006 | Designation | Order no | Type | =A1 | | |
| | | | Resp. | Schild | Plant section | | | | wir.diagram | 646324/646325/646326/ 646328/646329/646331 | TCG 2032 V16 | +T1 | | |
| | | | Chkd. | Bardel | Engine | | | | TEM-Evo-AGS | part number | Identure no. | page | 21 | |
| State | modif. | Date | name | Norm | 25.01.06 | Source | replacem. f. | | 1247 | 4827 | UE | 0479-91 | from | 40 |

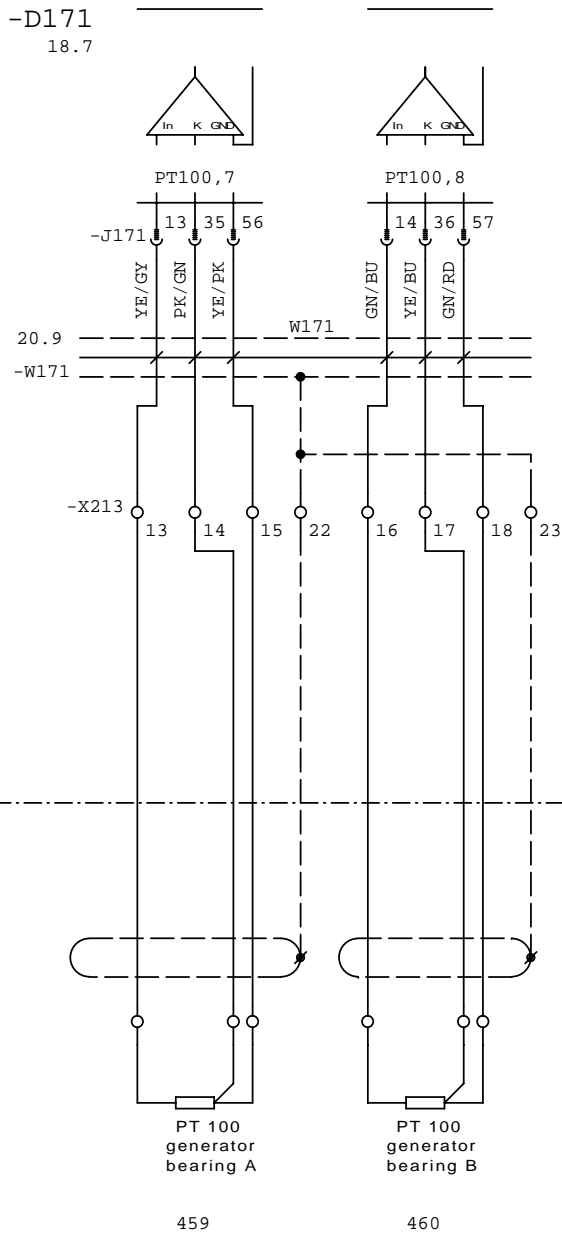

temperature measurement: generator bearings

| | | | | | | | | | | | | |
|-------|--------|------|-------|----------|---------------|------------------|--------------|---|--------------|---|--------------|------|
| | | | Date | 25.01.07 | Plant | Bogra Bangladesh | |  © 2006 | Designation | Order no | Type | =A1 |
| | | | Resp. | Schild | Plant section | | | | wir.diagram | 646324/646325/646326/ 646328/646329/646331 | TCG 2032 V16 | +T1 |
| | | | Chkd. | Bardel | Engine | | | | TEM-Evo-AGS | part number | Identure no. | page |
| State | modif. | Date | name | Norm | 25.01.06 | Source | replacem. f. | | 1247 4827 UE | 0479-91 | from | 40 |

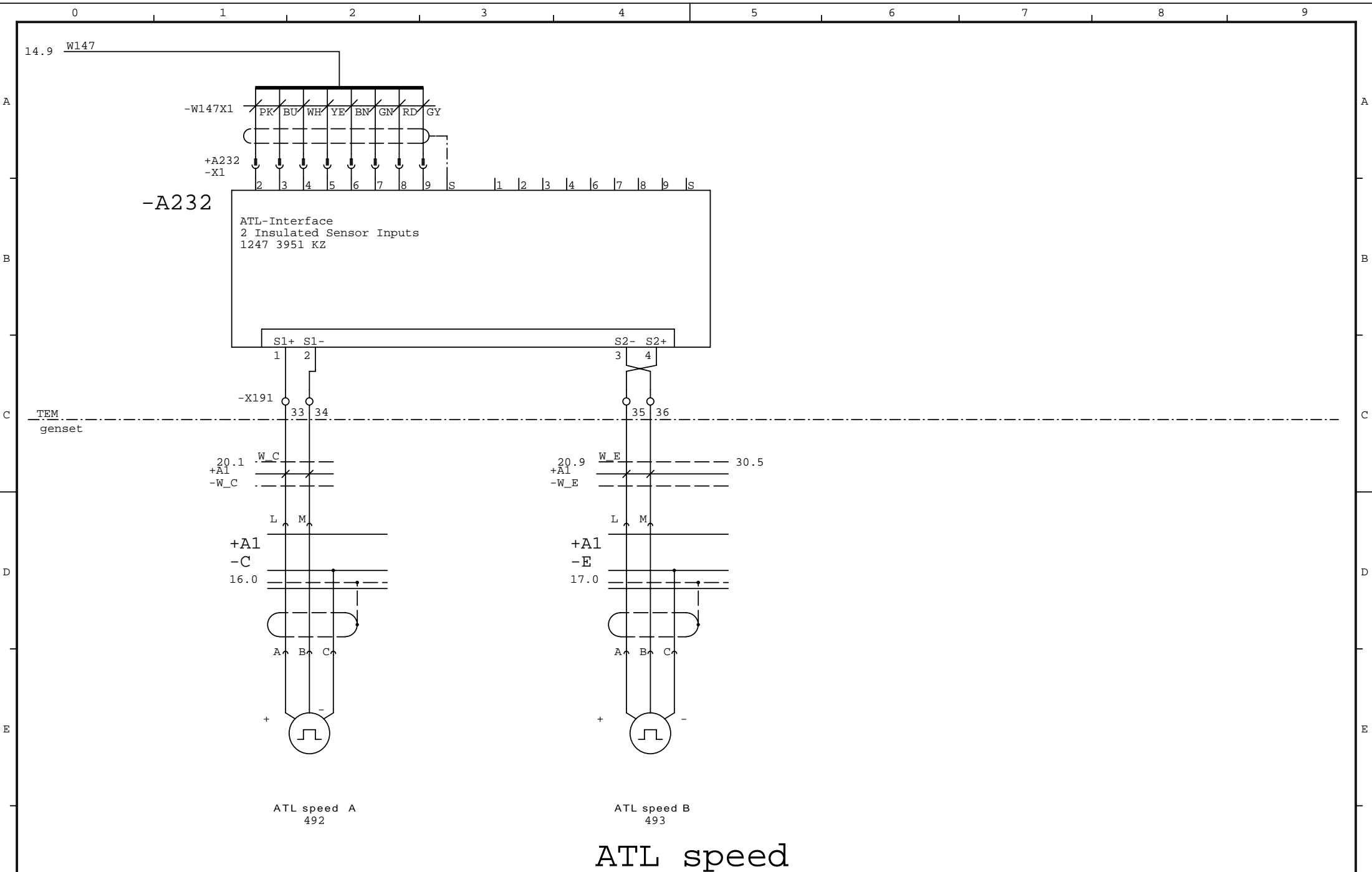

ATL speed

| | | | | | | | | | | | |
|-------|--------|------|-------|----------|---------------|------------------|---|--------------|---|--------------|----------|
| | | | Date | 25.01.07 | Plant | Bogra Bangladesh |  © 2006 | Designation | Order no. | Type | =A1 |
| | | | Resp. | Schild | Plant section | | | wir.diagram | 646324/646325/646326/ 646328/646329/646331 | TCG 2032 V16 | +T1 |
| | | | Chkd. | Bardel | Engine | | | TEM-Evo-AGS | part number | Identure no. | page |
| State | modif. | Date | name | Norm | 25.01.06 | Source | replacem. f. | 1247 4827 UE | 0479-91 | from | 23 40 |

0 1 2 3 4 5 6 7 8 9

A

A

B

B

C

C

D

D

E

E

F

F

reserved

| | | | | | | | | | | | |
|-------|--------|------|-------|----------|---------------|------------------|---|--------------|---|--------------|----------|
| | | | Date | 25.01.07 | Plant | Bogra Bangladesh |  © 2006 | Designation | Order no. | Type | =A1 |
| | | | Resp. | Schild | Plant section | | | wir.diagram | 646324/646325/646326/ 646328/646329/646331 | TCG 2032 V16 | +T1 |
| | | | Chkd. | Bardel | Engine | | | TEM-Evo-AGS | part number | Identure no. | page |
| State | modif. | Date | name | Norm | 25.01.06 | Source | replacem. f. | 1247 4827 UE | 0479-91 | from | 24 40 |

0 1 2 3 4 5 6 7 8 9

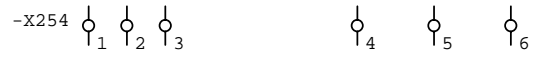

reserve terminals

| | | | | | | | | | | | |
|-------|--------|------|------|-------|----------|------------------------|---|-------------|---|--------------|--------------|
| | | | | Date | 25.01.07 | Plant Bogra Bangladesh |  © 2006 | Designation | Order no. | Type | =A1 |
| | | | | Resp. | Schild | Plant section | | wir.diagram | 646324/646325/646326/ 646328/646329/646331 | TCG 2032 V16 | +T1 |
| | | | | Chkd. | Bardel | Engine | | TEM-Evo-AGS | part number | 1247 4827 UE | Identure no. |
| State | modif. | Date | name | Norm | 25.01.06 | Source | replacem. f. | | | 0479-91 | from 40 |



reserve terminals

| | | | | | | | | | | | | | |
|-------|--------|------|------|-------|----------|---------------|------------------|-------------|---|---|--------------|--------------|---------|
| | | | | Date | 25.01.07 | Plant | Bogra Bangladesh | |  © 2006 | Designation | Order no. | Type | =A1 |
| | | | | Resp. | Schild | Plant section | | wir.diagram | | 646324/646325/646326/ 646328/646329/646331 | TCG 2032 V16 | +T1 | |
| | | | | Chkd. | Bardel | Engine | | TEM-Evo-AGS | | part number | 1247 4827 UE | Identure no. | 0479-91 |
| State | modif. | Date | name | Norm | 25.01.06 | Source | replacem. f. | | | | | | from 40 |

0 1 2 3 4 5 6 7 8 9

A

A

B

B

C

C

D

D

E

E

F

F

reserved

| | | | | | | | | | | | | | | | | | | |
|-------|--------|------|-------|----------|---------------|------------------|--------------|---|-------------|-------------|-----------|-----------|---|---------|------|--------------|--|---------|
| | | | Date | 25.01.07 | Plant | Bogra Bangladesh | |  © 2006 | Designation | wir.diagram | | Order no. | 646324/646325/646326/ 646328/646329/646331 | | Type | TCG 2032 V16 | | =A1 |
| | | | Resp. | Schild | Plant section | | | | | | | | | | | | | +T1 |
| | | | Chkd. | Bardel | Engine | | | | | | | | | | | | | |
| State | modif. | Date | name | Norm | 25.01.06 | Source | replacem. f. | | TEM-Evo-AGS | part number | 1247 4827 | UE | Identure no. | 0479-91 | | | | from 40 |

0 1 2 3 4 5 6 7 8 9

-D133
13.2

I/QX..1.15

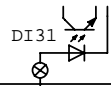

-J133
8

15.6
-W133

W133

34.0

RD

12.1 P157+

-X282
1 2

TEM
genset

exhaust back pressure
too high
opens for too
high pressure

157

transmitter exhaust back pressure

| | | | | | | | | | | | | |
|-------|--------|------|-------|----------|---------------|------------------|--------------|---|---|--------------|--------------|---------|
| | | | Date | 25.01.07 | Plant | Bogra Bangladesh | |  © 2006 | Designation | Order no. | Type | =A1 |
| | | | Resp. | Schild | Plant section | | wir.diagram | | 646324/646325/646326/ 646328/646329/646331 | TCG 2032 V16 | +T1 | |
| | | | Chkd. | Bardel | Engine | | TEM-Evo-AGS | | part number | 1247 4827 UE | Identure no. | 0479-91 |
| State | modif. | Date | name | Norm | 25.01.06 | Source | replacem. f. | | | | | from 40 |

-D291

anti-knock governor

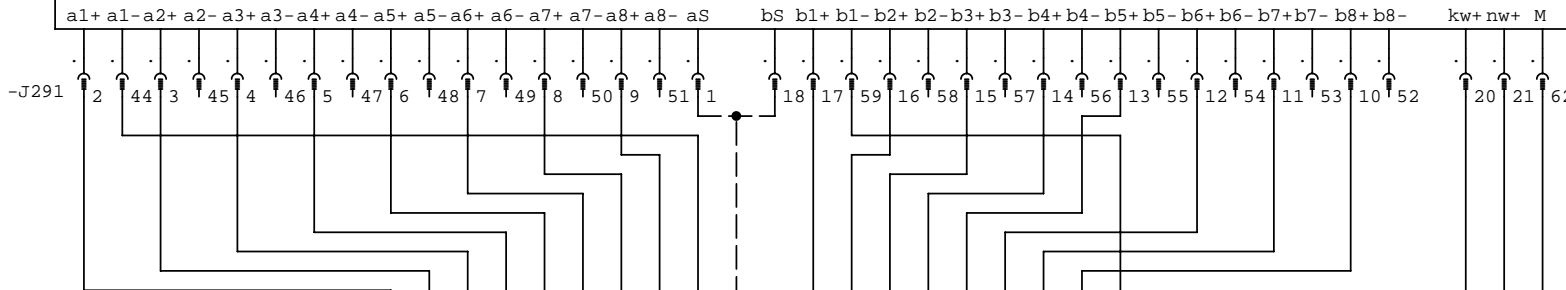

-A293

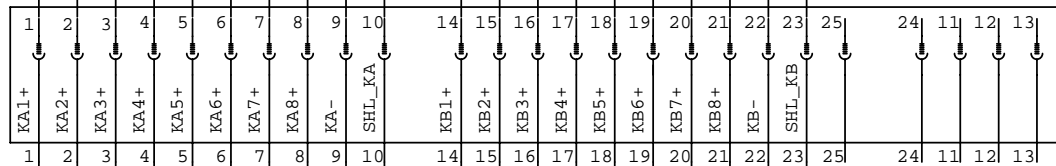

| | |
|-------------|------|
| S D291 | 30.0 |
| WH M D291 | 30.0 |
| BN nw+ D291 | 30.0 |
| GN kw+ D291 | 30.0 |

TEM
genset

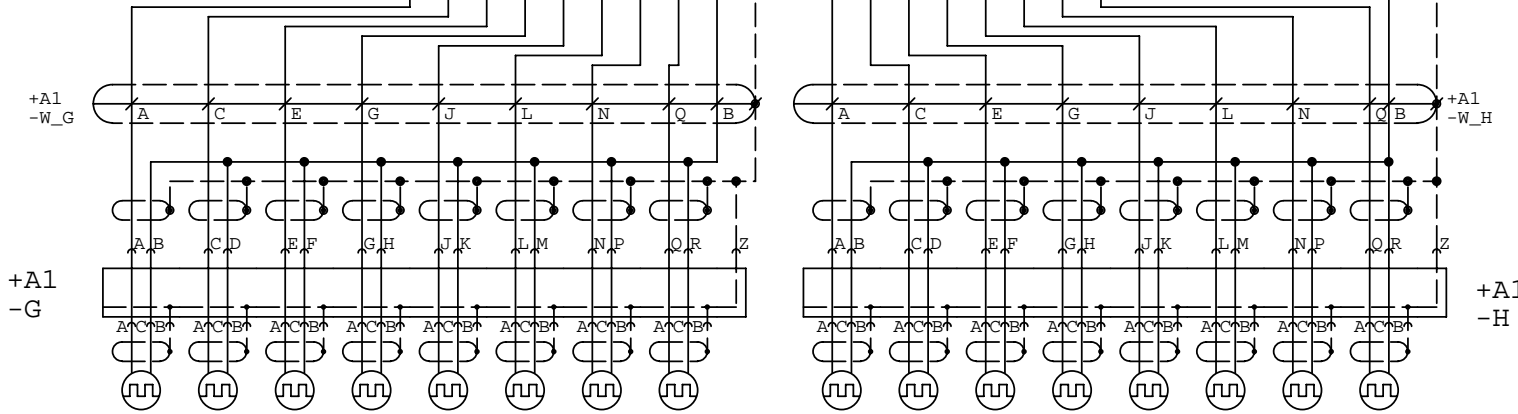

knock sensors bank A

241 242 243 244 245 246 247 248

251 252 253 254 255 256 257 258

knock sensors bank B

interface anti-knock governor

| | | | | | | | | | | |
|-----------------|----------|---------------|------------------|---|-------------|--------------|--------------|---|------|---------------------|
| Date | 25.01.07 | Plant | Bogra Bangladesh |  © 2006 | Designation | wir.diagram | Order no. | 646324/646325/646326/ 646328/646329/646331 | Type | =A1 TCG 2032 V16 |
| Resp. | Schild | Plant section | Engine | | part number | 1247 4827 UE | Identure no. | 0479-91 | page | 29 |
| State/Date/Name | 07.09.07 | Norm | 25.01.06 | | Source | replacem. f. | | | from | 40 |

reserved

| | | | | | | | | | | | |
|-------|--------|------|-------|----------|---------------|------------------|---|--------------|---|--------------|----------|
| | | | Date | 25.01.07 | Plant | Bogra Bangladesh |  © 2006 | Designation | Order no. | Type | =A1 |
| | | | Resp. | Schild | Plant section | | | wir.diagram | 646324/646325/646326/ 646328/646329/646331 | TCG 2032 V16 | +T1 |
| | | | Chkd. | Bardel | Engine | | | TEM-Evo-AGS | part number | Identure no. | page |
| State | modif. | Date | name | Norm | 25.01.06 | Source | replacem. f. | 1247 4827 UE | 0479-91 | from | 31 40 |

-D321

stepper motor card

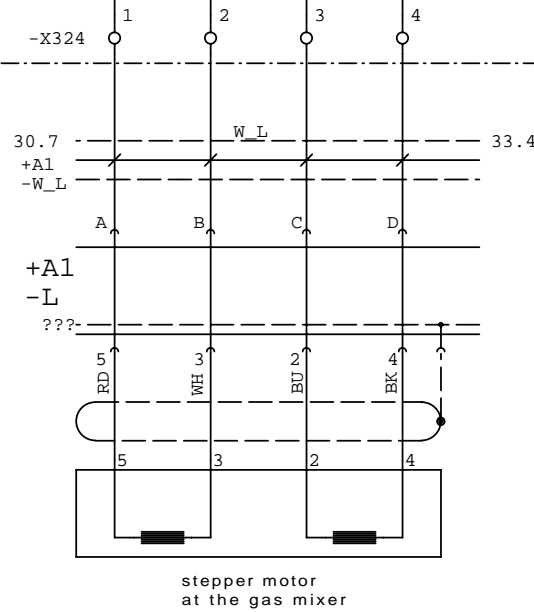
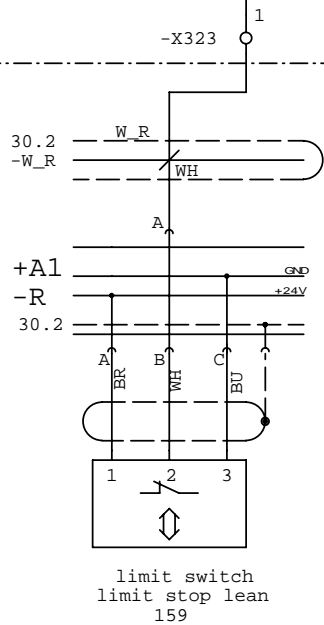
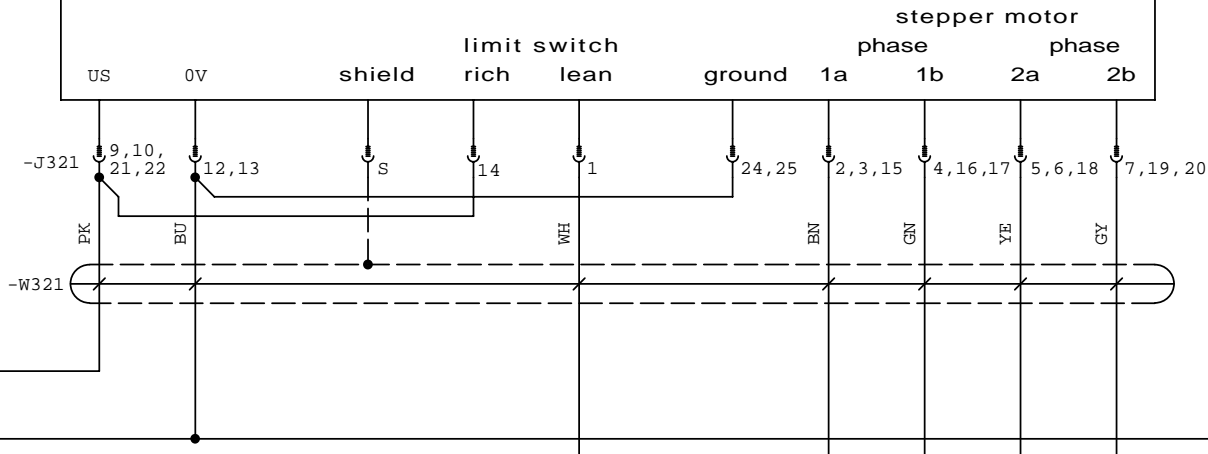

stepper motor card, mixer, bank A

| | | | | | | | | | | | |
|-------|--------|------|-------|----------|---------------|------------------|---|--------------|---|--------------|---------|
| | | | Date | 25.01.07 | Plant | Bogra Bangladesh |  © 2006 | Designation | Order no. | Type | =A1 |
| | | | Resp. | Schild | Plant section | | | wir.diagram | 646324/646325/646326/ 646328/646329/646331 | TCG 2032 V16 | +T1 |
| | | | Chkd. | Bardel | Engine | | | TEM-Evo-AGS | part number | Identure no. | page 32 |
| State | modif. | Date | name | Norm | 25.01.06 | Source | replacem. f. | 1247 4827 UE | 0479-91 | from 40 | |

-D331

stepper motor card

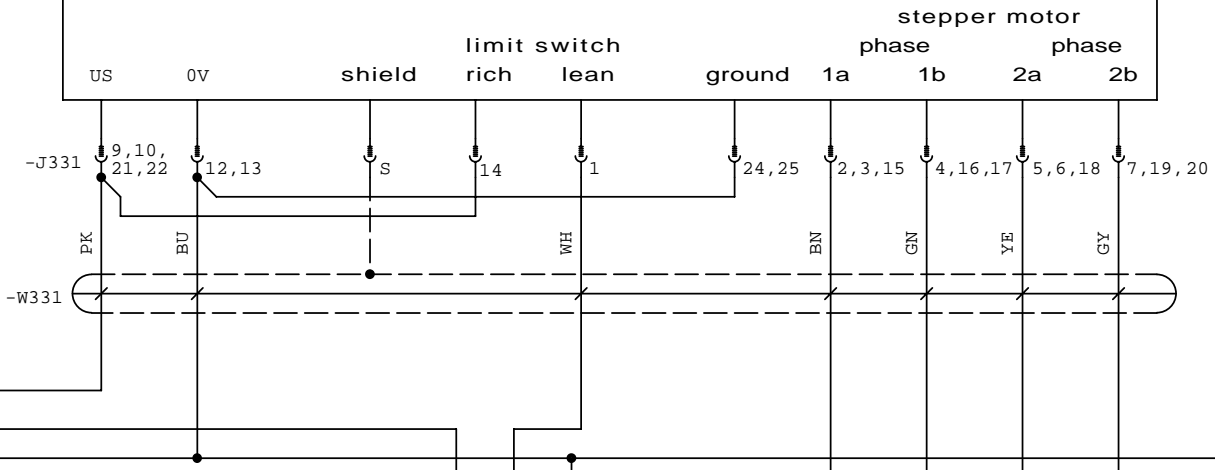

12.2 MS2:US
12.1 ES+
32.9 L-

L- 34.0

TEM
genset

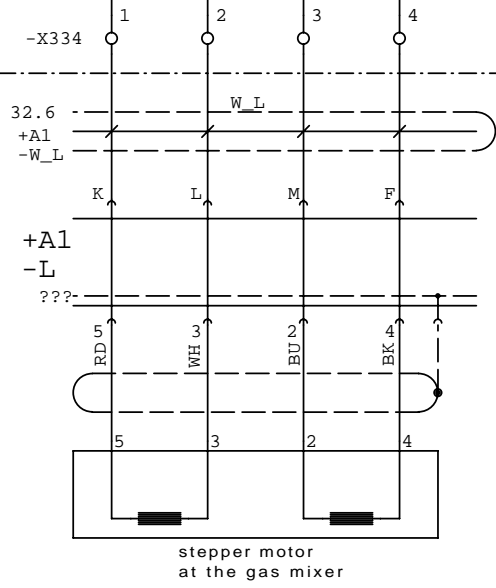
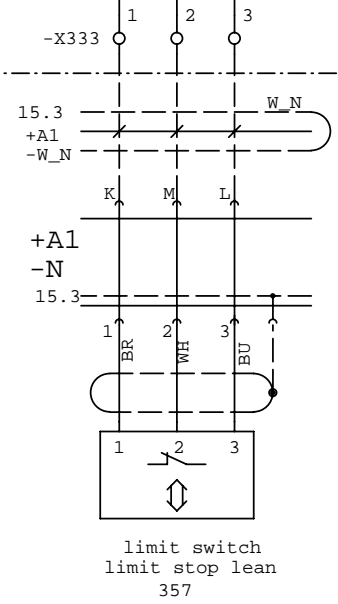

stepper motor card, mixer, bank B

| | | | | | | | | | | | |
|-------|--------|------|-------|----------|---------------|------------------|---|--------------|---|--------------|----------|
| | | | Date | 25.01.07 | Plant | Bogra Bangladesh |  © 2006 | Designation | Order no | Type | =A1 |
| | | | Resp. | Schild | Plant section | | | wir.diagram | 646324/646325/646326/ 646328/646329/646331 | TCG 2032 V16 | +T1 |
| | | | Chkd. | Bardel | Engine | | | TEM-Evo-AGS | part number | Identure no. | page |
| State | modif. | Date | name | Norm | 25.01.06 | Source | replacem. f. | 1247 4827 UE | 0479-91 | from | 33 40 |

-D133
13.2

I/QX..1.03 I/QX..1.04 I/QX..1.06 I/QX..1.08 I/QX..1.07 I/QX..1.09 I/QX..1.05

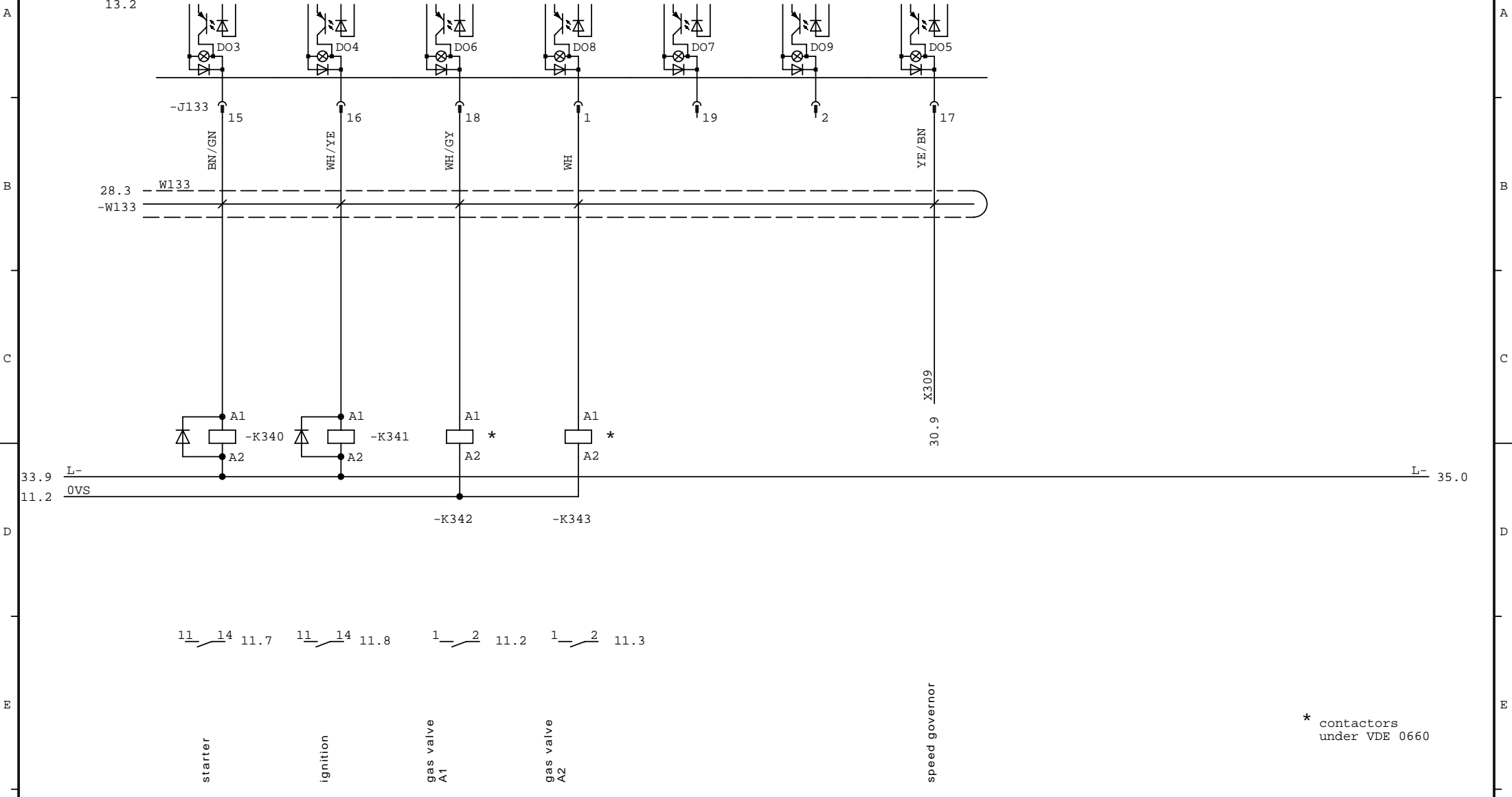

11-14 11.7 11-14 11.8 1-2 11.2 1-2 11.3

starter ignition gas valve A1 gas valve A2 speed governor

* contactors under VDE 0660

triggering aux. relay, speed governor, starter

| | | | | | | | | | | | |
|-------|--------|------|-------|----------|---------------|------------------|---|--------------|---|--------------|----------|
| | | | Date | 25.01.07 | Plant | Bogra Bangladesh |  © 2006 | Designation | Order no. | Type | =A1 |
| | | | Resp. | Schild | Plant section | | | wir.diagram | 646324/646325/646326/ 646328/646329/646331 | TCG 2032 V16 | +T1 |
| | | | Chkd. | Bardel | Engine | | | TEM-Evo-AGS | part number | Identure no. | page |
| State | modif. | Date | name | Norm | 25.01.06 | Source | replacem. f. | 1247 4827 UE | 0479-91 | from | 34 40 |

-D361

mounted in -D144

TTY interface

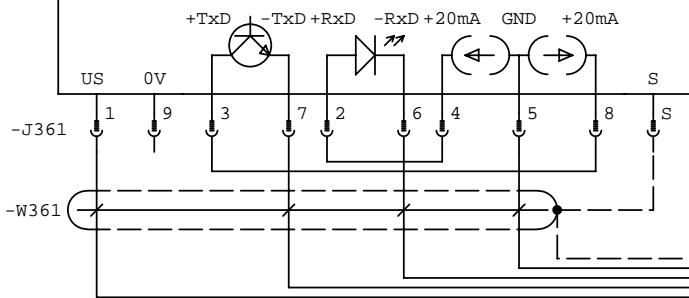

-D365

mounted in -D144

TTY interface

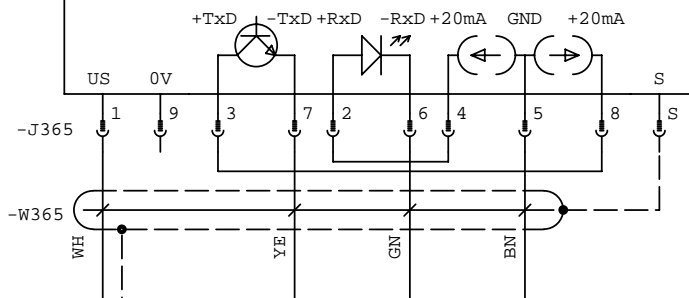

connection service PC

-A364

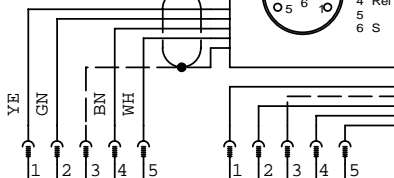
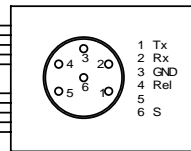

-D364
FAE-M

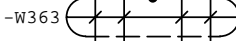
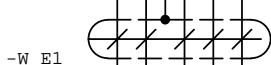
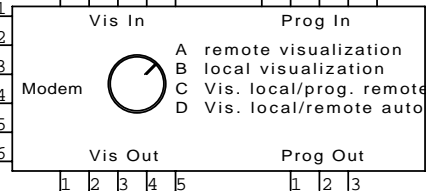

-X362

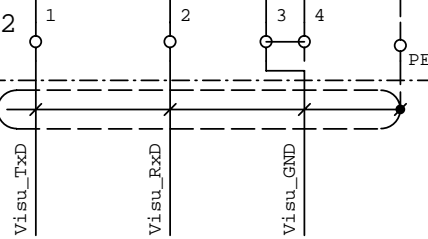

-W_B1

35.9 L-
12.8 R1+
35.9 PE

TEM
external

see wiring diagram
TEM-Evo modem system
1247 4829 UE 0479-91

see wiring diagram
TEM-Evo-I/O-Controller
1247 4828 UE 0479-91

intelligent selection unit

operating terminal

interface to operating terminal and IAE

| | | | | | | | | |
|--------|----------|---------------|------------------|---|--------------|--------------|--------------|-------------|
| Date | 25.01.07 | Plant | Bogra Bangladesh |  | Designation | Order no. | Type | =A1 |
| Resp. | Schild | Plant section | Engine | | | | | wir.diagram |
| State | 07.09.07 | name | Bardel | © 2006 | TEM-Evo-AGS | part number | Identure no. | page 36 |
| modif. | Date | Norm | 25.01.06 | Source | replacem. f. | 1247 4827 UE | 0479-91 | from 40 |

0 1 2 3 4 5 6 7 8 9

A

A

B

B

C

C

D

D

E

E

F

F

reserved

| | | | | | | | | | | | | | | | | | | |
|-------|--------|------|-------|----------|---------------|------------------|--------------|---|-------------|-------------|-----------|-----------|---|---------|------|--------------|--|---------|
| | | | Date | 25.01.07 | Plant | Bogra Bangladesh | |  © 2006 | Designation | wir.diagram | | Order no. | 646324/646325/646326/ 646328/646329/646331 | | Type | TCG 2032 V16 | | =A1 |
| | | | Resp. | Schild | Plant section | | | | | | | | | | | | | +T1 |
| | | | Chkd. | Bardel | Engine | | | | | | | | | | | | | |
| State | modif. | Date | name | Norm | 25.01.06 | Source | replacem. f. | | TEM-Evo-AGS | part number | 1247 4827 | UE | Identure no. | 0479-91 | | | | from 40 |

0 1 2 3 4 5 6 7 8 9

-A380

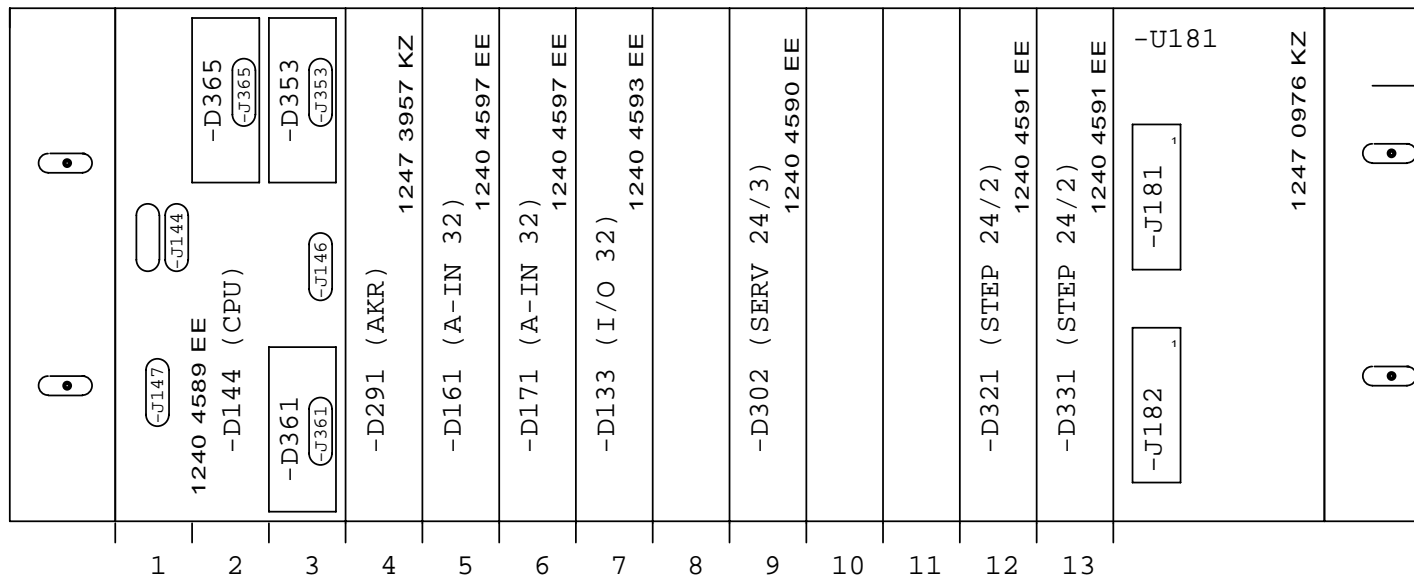

CPU

knock governor

analog input

analog input

digital input/output

empty slot
(blind covering)

speed governor

empty slot
(blind covering)

empty slot
(blind covering)

stepper motor card
mixer A

stepper motor card
mixer B

power supply

supply 24V

slot overview TEM terminal

| | | | | | | | | | | | |
|-------|--------|------|-------|----------|---------------|------------------|---|--------------|---|--------------|----------|
| | | | Date | 25.01.07 | Plant | Bogra Bangladesh |  © 2006 | Designation | Order no. | Type | =A1 |
| | | | Resp. | Schild | Plant section | | | wir.diagram | 646324/646325/646326/ 646328/646329/646331 | TCG 2032 V16 | +T1 |
| | | | Chkd. | Bardel | Engine | | | TEM-Evo-AGS | part number | Identure no. | page |
| State | modif. | Date | name | Norm | 25.01.06 | Source | replacem. f. | 1247 4827 UE | 0479-91 | from | 38 40 |

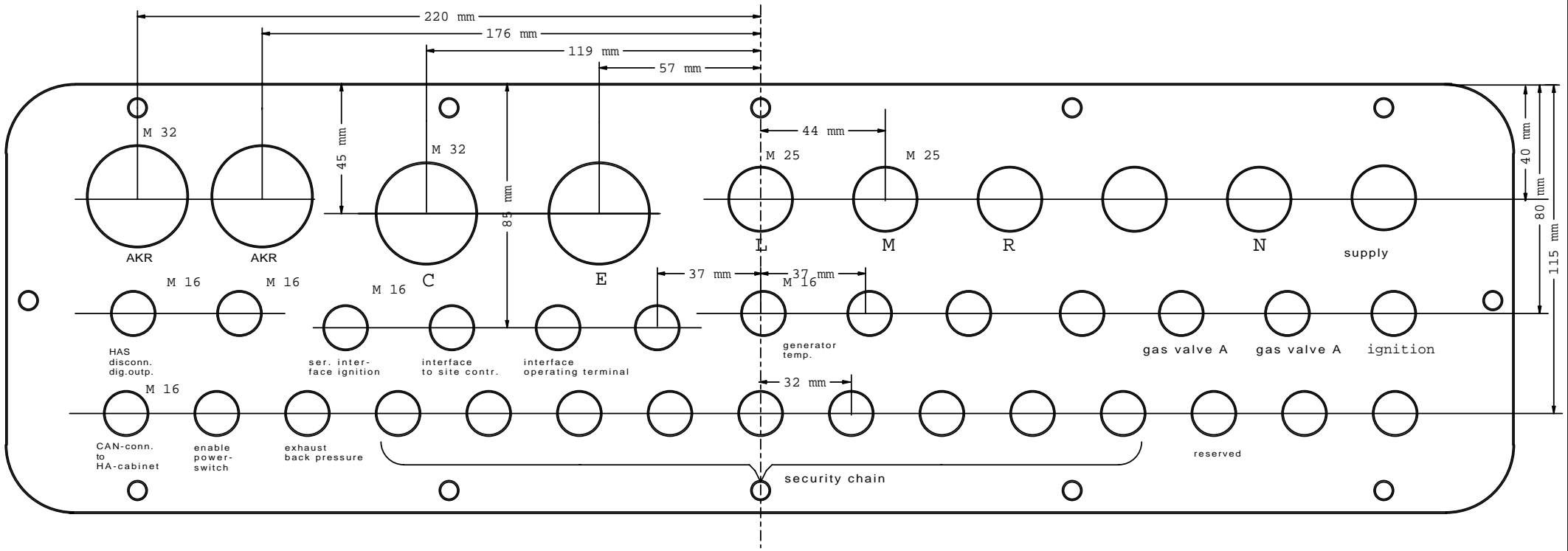

bores

- M 16: 16.5 mm
- M 25: 25.5 mm
- M 32: 32.5 mm

cable inlets base plate

| | | | | | | | | | | | | | |
|-------|--------|------|------|-------|----------|---------------|------------------|-------------|---|---|--------------|--------------|---------|
| | | | | Date | 25.01.07 | Plant | Bogra Bangladesh | |  © 2006 | Designation | Order no. | Type | =A1 |
| | | | | Resp. | Schild | Plant section | | wir.diagram | | 646324/646325/646326/ 646328/646329/646331 | TCG 2032 V16 | +T1 | |
| | | | | Chkd. | Bardel | Engine | | TEM-Evo-AGS | | part number | 1247 4827 UE | Identure no. | 0479-91 |
| State | modif. | Date | name | Norm | 25.01.06 | Source | replacem. f. | | | | | | from 40 |

material list

| No. | Qty. | name | item No. | DEUTZ ref. no. | supplier | reference | remark |
|-----|------|--|-----------|----------------|----------|---------------------------------------|--------|
| 1 | 1 | Circuit breaker 3A type C | 5 700 550 | | DEUTZ | =A1+T1-F128 | |
| 2 | 1 | circuit breaker 6A type B | 5 700 510 | | DEUTZ | =A1+T1-F125 | |
| 3 | 1 | circuit breaker 0.5A type C | 5 700 530 | | DEUTZ | =A1+T1-F110 | |
| 4 | 3 | circuit breaker 6A type B, w/aux. contact | 5 700 500 | | DEUTZ | =A1+T1-F122, =A1+T1-F121, =A1+T1-F127 | |
| 5 | 1 | circuit breaker 0.5A type Z | 5 700 560 | | DEUTZ | =A1+T1-F130 | |
| 6 | 3 | CONTACTOR 3RT1016-2BB42, DC 24V | 5 800 430 | | DEUTZ | =A1+T1-K110, =A1+T1-K342, =A1+T1-K343 | |
| 7 | 4 | Relay coupler 24 VDC | 4 500 153 | | DEUTZ | =A1+T1-K136, =A1+T1-K37, =A1+T1-K341 | |
| | | | | | | =A1+T1-K340 | |
| 8 | 1 | VMEbus-card DZR SERV 24/3-1 | 4 000 003 | 1240 4590 EE | DEUTZ | =A1+T1-D302 | ** |
| 9 | 1 | VMEbus board I/O 32-1 | 4 000 004 | 1240 4593 EE | DEUTZ | =A1+T1-D133 | ** |
| 10 | 2 | VME bus-card SMK STEP 24/2-1 | 4 000 018 | 1240 4591 EE | DEUTZ | =A1+T1-D331, =A1+T1-D321 | ** |
| 11 | 1 | Anti-knock governor card DSP-AKR-1 | 4 000 021 | 1247 3957 KZ | DEUTZ | =A1+T1-D291 | ** |
| 12 | 1 | Terminal interface module AKR | 4 000 040 | 1240 4587 EE | DEUTZ | =A1+T1-A293 | |
| 13 | 1 | Emergency cutoff module SRB-NA-C.6-24VDC | 4 000 053 | 1247 0915 EE | DEUTZ | =A1+T1-A110 | |
| 14 | 1 | module SERMOD 1.0 | 4 000 055 | 1240 4596 EE | DEUTZ | =A1+T1-A132 | |
| 15 | 1 | Watchdog WAT24-1 | 4 000 061 | 1240 4599 EE | DEUTZ | =A1+T1-A137 | |
| 16 | 1 | VMEbus-CPU unit CPU-1 | 4 000 071 | 1240 4589 EE | DEUTZ | =A1+T1-D144 | ** |
| 17 | 2 | VMEbus board A-IN 32-1 | 4 000 080 | 1240 4597 EE | DEUTZ | =A1+T1-D171, =A1+T1-D161 | ** |
| 18 | 1 | function selection unit FAE-M | 4 000 095 | 1247 0982 KZ | DEUTZ | =A1+T1-D364 | |
| 19 | 1 | service PC (SPC) | 4 000 098 | | DEUTZ | =A1+T1-A364 | |
| 20 | 1 | VMEbus subrack (RACK13) | 4 000 161 | 1247 0974 KZ | DEUTZ | =A1+T1-A380 | |
| 21 | 1 | VMEbus supply unit PS50 | 4 000 162 | 1247 0976 KZ | DEUTZ | =A1+T1-U181 | |
| 22 | 1 | Emergency cutoff mushroom-push button switch | | | | =A1+T1-S134 | |
| 23 | 1 | ATL-Interface | 4 500 670 | 1247 3951 KZ | DEUTZ | =A1+T1-A232 | |
| 24 | 2 | Auxiliary contact S2-H11 | 5 700200 | | DEUTZ | | |
| 25 | 1 | Circuit breaker 3A type C | 5 700 220 | | DEUTZ | =A1+T1-F111 | |
| 26 | 3 | circuit breaker 6A type B | 5 700 130 | | DEUTZ | =A1+T1-F118, =A1+T1-F124, =A1+T1-F120 | |

* not delivered by Deutz

** Please state order no. when ordering spare part

| | | | | | | | | | | | | |
|-------------|------|------|-------|----------|---------------|------------------|--|---|--------------|---|--------------|------|
| | | | Date | 25.01.07 | Plant | Bogra Bangladesh | |  © 2006 | Designation | Order no. | Type | =A1 |
| | | | Resp. | Schild | Plant section | | | | wir.diagram | 646324/646325/646326/ 646328/646329/646331 | TCG 2032 V16 | +T1 |
| | | | Chkd. | Bardel | Engine | | | | TEM-Evo-AGS | part number | Identure no. | page |
| Statemodif. | Date | name | Norm | 01.10.03 | Source | replacem. f. | | | 1247 4827 UE | 0479-91 | from | 40 |